

Panasonic

ideas for life

LC-P1242

For standby power supplies
 Expected trickle life: 6 years at 25°C
 10 years at 20°C



※Contents indicated (including the recycle marking, etc) are subject to change without notice.

■Dimensions(mm)

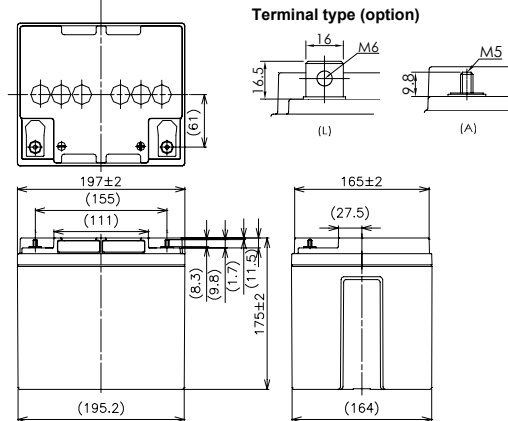

Battery case resin: Flame-retardant (UL94V-0)

■Specification

Nominal Voltage		12V
Rated Capacity(20HR)		42Ah
Dimensions	Length	197 mm
	Width	165 mm
	Height	175 mm
	Total height	175 mm/180mm
Approx. Mass		13.5 kg
Terminal		M5 & M6 threaded post

■Characteristics

Capacity (25 °C)	20 hour rate	42Ah
	10 hour rate	40Ah
	3 hour rate	31Ah
	1 hour rate	26Ah
Internal Resistance (25 °C)	Fully charged battery	10 mΩ
Temperature Dependency of Capacity (20 hour rate)	40 °C	102%
	25 °C	100%
	0 °C	85%
	-15 °C	65%
Self Discharge (25 °C)	After 3 months	91%
	After 6 months	82%
	After 12 months	64%

■Duration of discharge vs. discharge current

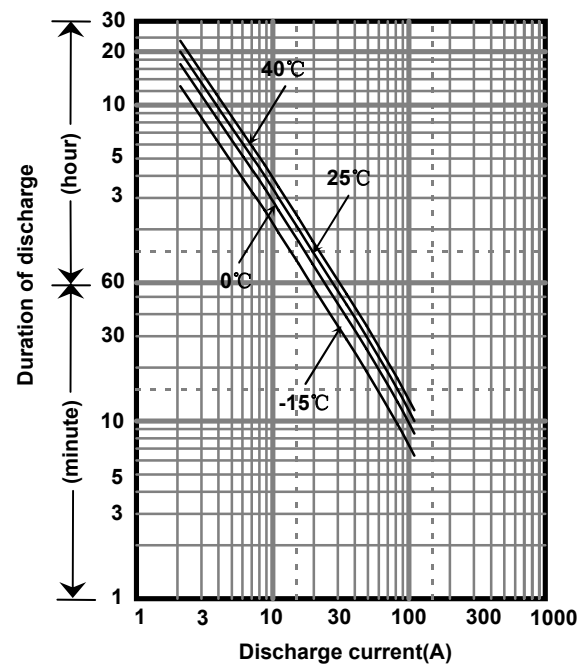

■Watt Table(25°C)

Cut-off V	(Wattage/Battery)														
	5min	10min	15min	20min	30min	45min	1h	1.5h	2h	3h	4h	5h	6h	10h	20h
9.6V	1483	1254	966	835	625	410	312	241	187	132	110	89.9	79.1	48.0	25.2
9.9V	1405	1232	955	824	607	407	310	234	186	130	109	89.4	78.5	48.0	25.2
10.2V	1327	1210	943	812	596	406	307	217	184	127	108	88.9	77.9	48.0	25.2
10.5V	1249	1176	920	800	585	405	306	211	179	126	107	88.5	76.7	48.0	25.2
10.8V	1215	1086	886	777	573	390	295	201	173	121	105	87.5	75.5	48.0	25.2

■Ampere Table(25°C)

Cut-off V	(Ampere/Battery)														
	5min	10min	15min	20min	30min	45min	1h	1.5h	2h	3h	4h	5h	6h	10h	20h
9.6V	133	112	84.0	72.0	53.4	34.9	26.5	20.4	15.8	11.1	9.20	7.50	6.60	4.00	2.10
9.9V	126	110	83.0	71.0	51.9	34.7	26.3	19.8	15.7	10.9	9.10	7.46	6.50	4.00	2.10
10.2V	119	108	82.0	70.0	50.9	34.6	26.1	18.4	15.5	10.7	9.00	7.42	6.50	4.00	2.10
10.5V	112	105	80.0	69.0	50.0	34.5	26.0	17.9	15.1	10.6	8.90	7.38	6.40	4.00	2.10
10.8V	109	97.0	77.0	67.0	49.0	33.2	25.0	17.0	14.6	10.2	8.80	7.30	6.30	4.00	2.10

All mentioned values are average values

Charging Method (25°C)

Trickle use	Control voltage:13.6-13.8V Initial current:6.30A or smaller
-------------	--

Cut off voltage

Discharge current	2.10A-8.40A	8.40A-21.0A	21.0A-42.0A	42.0A-84.0A	84.0A-126A
Cut off voltage(V)	10.5	10.2	9.9	9.3	8.7

Influence of Temperature on Trickle life

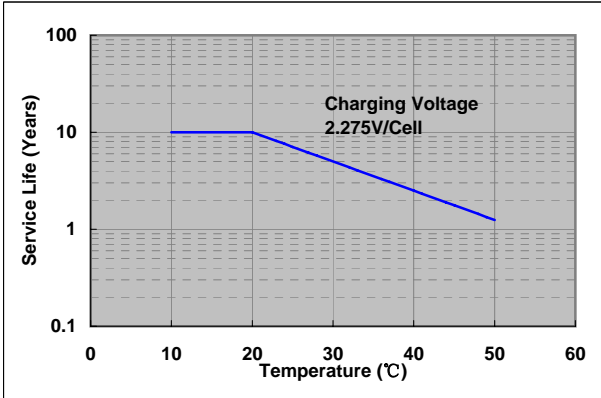

Residual capacity test result

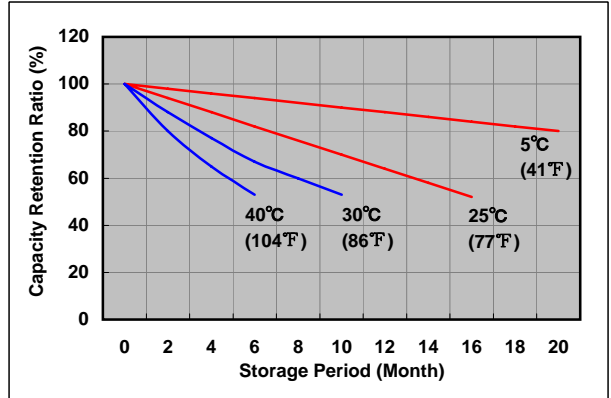

Constant-voltage constant-current charge characteristics for Trickle use

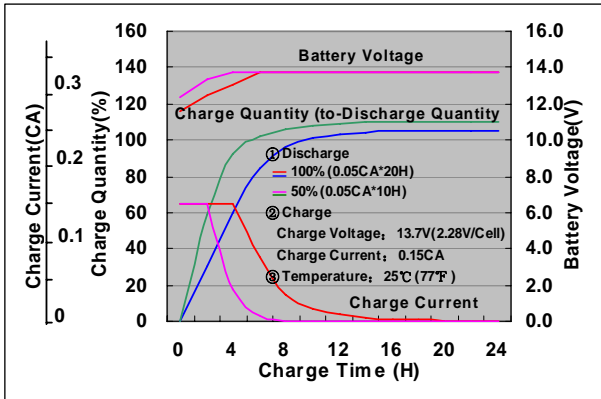

Discharge capacity by temperature and by discharge current

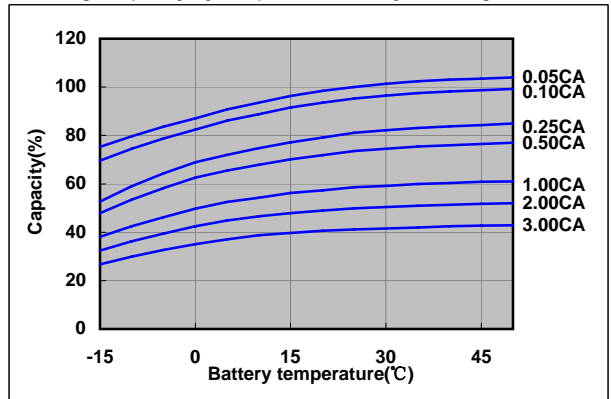

Discharge characteristics(25°C)

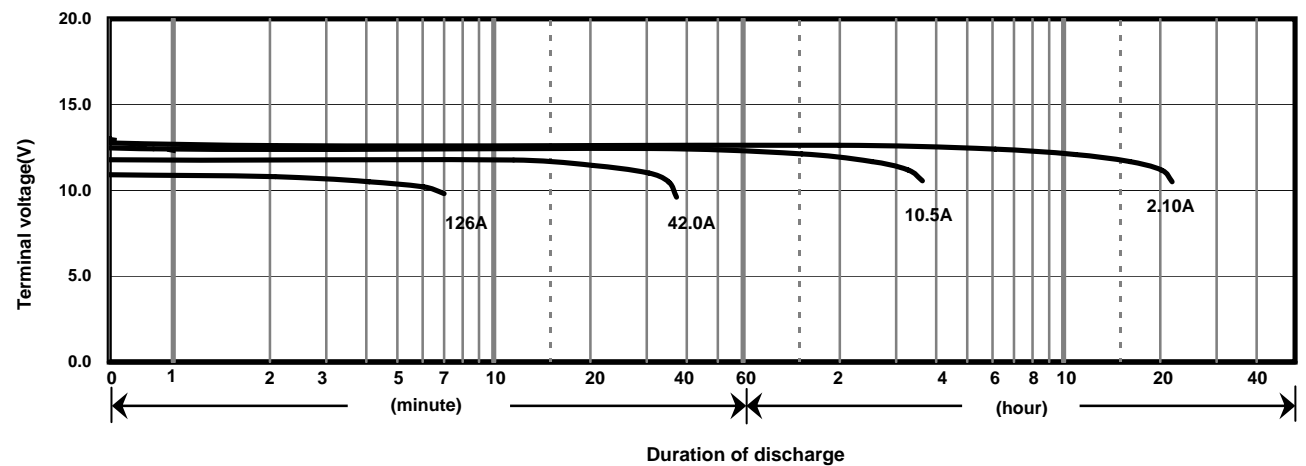

Caution

Due to the potential energy stored in the batteries, Please read 《Precautions for handling the Rechargeable Valve Regulated Lead Acid Batteries》 before using batteries. If improper handling or use of the batteries without understanding 《Precautions for handling the Rechargeable Valve Regulated Lead Acid Batteries》 may result in bodily injury caused by electrolyte leakage, heat generation, or explosion.

Panasonic Storage Battery (Shenyang) Co., Ltd

NO. 51 Kunminghu Street, Shenyang Economic & Technical Development Zone, 110141 China
Tel: 86 24 25818921
Fax: 86 24 62786318
Website: <http://www.panasonicbattery.cn>

2011.12